

2022

INTERIOR
SAFETY



ADV PRIME

HOMOLOGATION: FIA 8862-2009
 MATERIAL: CARBON FIBER
 WEIGHT (GR): SHELL: 8300 / SEAT: 10500
 - Developed in collaboration with M-sport.
 - New lining design.
 - Self-extinguishing fabric lining
 - FIA approved energy absorbing padding.
 - M12 side fixings with 290 mm center distance.
 - New use of the k-point fabric
 - One-piece cushion with separate leg rest
 - The seat is approved in conjunction with the 004990ADV side mounting brackets.

Code	Colour	Size
008033ZNR	Black	Regular



ADV PRIME PAD

HOMOLOGATION: FIA 8862-2009
 MATERIAL: CARBON FIBER
 WEIGHT (GR): SHELL: 8300 / SEAT: 10500
 - Developed in collaboration with M-sport.
 - NEW UPHOLSTERY DESIGN WITH REMOVABLE PAD IN DOUBLE DENSITY FOAM
 - Self-extinguishing fabric lining
 - FIA approved energy absorbing padding.
 - M12 side fixings with 290 mm center distance.
 - New use of the k-point fabric
 - One-piece cushion with separate leg rest
 - The seat is approved in conjunction with the 004990ADV side mounting brackets.

Code	Colour	Size
008033ZPNR	Black	Regular



ADV XT CARBON

The lightest seat with FIA 8862 ever produced by Sparco.
 The driver seat has been improved to give greater comfort, for both road and circuit races. Self-extinguishing fabric. IA protection for areas in contact with the driver's body.
 THE SEAT IS APPROVED IN CONJUNCTION WITH THE SIDE MOUNTING FRAMES 0049605

Code	Colour	Size
008002ZNR	Black	Regular



ADV ELITE CARBON

FIA 8862 compliant, Lightest in this category, Self extinguish fabric IA protection in specific areas (body contact).
 Lateral fixing (290 mm)
 THE SEAT IS APPROVED IN CONJUNCTION WITH THE SIDE MOUNTING FRAMES 004988ADV

Code	Colour	Size
00849ZNR	Black	Single size



sparco
ADV-SCX CARBON

Using the Pro ADV as a base, the ADV SC features a 'Super Carbon' material construction. Using less resin than the standard autoclaving technique, this leaves more pure carbon in the shell and reduces the weight further. The seat is fully HANS compatible for use in professional motorsport and features reinforced wear patches on the edges of the seat. For taller drivers, there is also a version of the seat with increased height. Further weight saving is also available with an Ultra Lightweight edition which saves approximately a further 3kg, also with an increased height version.

- FIA Approved
- 'Super Carbon' Construction
- Ultra Lightweight
- Reinforced Wear Patches On Seat Edges
- Increased Height Version Available

Code	Colour	Size
00804ZNR	Black	Regular
00805ZNR	Black	High



sparco
ADV SC CARBON

Homologation: FIA 8862-2009

WEIGHT (g)
SHELL: 10485
SEAT: 12000

With strength at the top of its class and able to withstand over 3,000 kg of lateral force, the ADV SC seat has an energy-absorption system in the areas subjected to the highest stress, a lining in self-extinguishing fabric and a non-slip fabric for restraining the shoulders and for the seat. Fixed using lateral fastenings with 290 mm spacing.

The seat is approved in conjunction with the side mounting frames: 004982ADV

Code	Colour	Size
008020ZNR	Black	Single size



sparco
ADV COMPETITION

HOMOLOGATION: FIA 8862-2009

Seat designed in collaboration with M-Sport
Ergonomics designed for professional pilots
Shaped backrest to wrap the rider
Backrest with additional reinforcement in the lumbar area
Efficient construction technology

Code	Colour	Size
008034ZNR	Black	Regular



sparco
ADV COMPETITION PAD

HOMOLOGATION: FIA 8862-2009

Seat designed in collaboration with M-Sport
Ergonomics designed for professional pilots
Shaped backrest to wrap the rider
Backrest with additional reinforcement in the lumbar area
Efficient construction technology

ADV COMPETITION UPGRADED WITH SPECIAL REMOVABLE PAD IN DOUBLE DENSITY FOAM UPHOLSTERY

Code	Colour	Size
008034ZPNR	Black	Regular



MASTER

HOMOLOGATION: FIA 8855-2021
 MATERIAL: FIBERGLASS
 WEIGHT (GR): SHELL: 11250 / SEAT: 14000
 - New seat compliant with the more stringent 8855-2021 homologation.
 - Internal memory foam pad insertion.
 - Suitable for pilots of height between 1.75 - 1.95 m.
 - Non-slip fabric for shoulders and seat
 - Shock absorber foam on the separate head
 - Integrated racing net guides

The seat is homologated in combination with the 004919 side mounting brackets

Code	Colour	Size
008030FNR	Black	Regular



ADV XT

HOMOLOGATION: FIA 8855-2021
 MATERIAL: FIBERGLASS
 WEIGHT (GR): SHELL: 9700 / SEAT: 12000
 - Self-extinguishing fabric lining.
 - Separate leg rest cushion
 - Suitable for pilots of height between 1.65 - 1.80 m
 - Fixing of M12 side connections with center distance at 290 mm
 - FIA approved energy absorbing padding.
 - Integrated racing net guides.

The seat is homologated with two height adjustment possibilities (in combination with the 004932H and 004932L side mounting brackets).

Code	Colour	Size
008032FNR	Black	Regular



MATRIX 8855-2021

HOMOLOGATION: FIA 8855-2021
 Developed according to the new technical regulations 8855-2021.
 Special reinforcement sheet with honeycomb matrix and painting with new semi-transparent technology
 Designed for greater ergonomics using SAE manikin.
 New efficient construction technology.

Code	Colour	Size
008036SNR	Black	Regular



QRT-C CARBON

Homologation: FIA 8855-1999
 Material: carbon
 Design and functionality
 - Self-extinguishing fabric lining
 - Non-slip fabric for shoulders and seat
 - High structural strength
 - Fixed using M8 lateral fastenings with 290 mm spacing.
 Shell weight (g): 4300
 Seat weight (g): 5500

Code	Colour	Size
008025ZNR	Black	Single size



LEGEND

Homologation: FIA 8855-1999
 Material: Carbon-Kevlar
 Weight (gr):
 SHELL: 5600
 SEAT: 6000
 ORIGINAL REPLICA OF SPARCO SEATS USED IN THE 80S ON LEADING RALLY CARS.
 Pre-preg carbon-kevlar frame.
 VEP fabric with original checkered lining.
 Lower fasteners 317x345 (M8) (does not mount on guide 00943..).

Code	Colour	Size
008021ZNR	Black	Single size
008021ZRS	Red	Single size



EVO CARBON

Homologation: FIA 8855-1999
 Material: Carbon
 Unparalleled comfort and performance
 - Superlight carbon shell
 - Self-extinguishing fabric lining
 - New non-slip fabric for shoulder and seat restraint
 - Divisible legrest and seat cushion
 - Fixed using M8 lateral fastenings with 290 mm spacing

Code	Colour	Size
008007ZNR	Black	Regular
008013ZNR	Black	Large
008015ZNR	Black	Extra Large



ULTRA CARBON

Homologation: FIA 8855-1999
 MATERIAL: Carbon fiber
 WEIGHT (g): SHELL/SEAT: 3800
 NO HRS
 Ultralight seat. Suitable for narrow cockpits.
 Laminated with double carbon fiber shell.
 Ergonomics designed for use without padding

Codice	Colour	Size
008037ZNR	Black	Single size



CIRCUIT / CIRCUIT II CARBON

Homologation: FIA 8855-1999
 Material: Carbon
 Ideal for Touring and Rally races
 - Superlight carbon shell
 - Non-slip fabric for shoulder and seat restraint
 - Divisible legrest and seat cushion
 - Available in 2 sizes (Circuit II Carbon size L), with integrated HRS (Head Restraint System).
 - Fixed using M8 lateral fastenings with 290 mm spacing.

Code	Colour	Size
008011ZNR	Black	Regular
008019ZNR	Black	Large



Homologation: FIA 8855-1999
 MATERIAL: Fiberglass
 WEIGHT (g): SHELL/SEAT: 5200
 NO HRS
 Ultralight seat. Suitable for narrow cockpits.
 Laminated with double fiberglass shell.
 Ergonomics designed for use without padding

Code	Colour	Size
008037FNR	Black	Single size



Homologation: FIA 8855-1999
 WEIGHT (g)
 SHELL: QRT-R: 5900; QRT-R SKY: 5900
 SEAT: QRT-R: 7100; QRT-R SKY: 8000
 Designed using the most innovative CAD software available, the QRT-R seat is built around a brand new concept. The frame has been designed to be installed even in the narrowest car interiors, and its aggressive design emphasizes the seat's racing pedigree and increases its structural rigidity. It has a new cushion divided into 2 parts and new stitching, in two configurations: saddling in fabric or sky.
 Fixed using lateral fastenings with 290 mm spacing.

Code	Colour	Size
008012RNR	Black	Single size
008012RNRSKY	Black Sky	Single size



Homologation: FIA 8855-1999
 Material: QRT
 - Non-slip fabric for shoulder and seat restraint
 - Divisible legrest and seat cushion
 - Lateral kidney supports
 - Fixed using M8 lateral fastenings with 290 mm spacing.
 - Fixed using bottom connectors directly on the bases.
 Shell weight (g): 6800
 Seat weight (g): 8000

Code	Colour	Size
008016RNR	Black	Single size



Homologation : FIA 8855-1999
 Material : QRT
 Ideal for Touring and Rally races
 - Self-extinguishing fabric lining
 - Non-slip fabric for shoulder and seat restraint
 - Divisible legrest and seat cushion
 - Fixed using M8 lateral fastenings with 290 mm spacing.
 Shell weight (g): 7800
 Seat weight (g): 9300

Code	Colour	Size
008017RNR	Black	Single size



sparco
CIRCUIT / II QRT

Homologation: FIA 8855-1999
Material: QRT
Ideal for Touring and Rally races
- Non-slip fabric for shoulder and seat restraint
- Divisible legrest and seat cushion
- Available in 2 sizes (Circuit II size L), with integrated HRS (Head Restraint System).
- Fixed using M8 lateral fastenings with 290 mm spacing.
Shell weight (g): CIRCUIT QRT: 7100, CIRCUIT II QRT: 7200
Seat weight (g): CIRCUIT QRT: 8600, CIRCUIT II QRT: 9600

Code	Colour	Size
008011RNR	Black	L
008019RNR	Black	Regular



sparco
EVO / EVO SKY QRT

Homologation: FIA 8855-1999
Material: QRT
Unparalleled comfort and performance
- Non-slip fabric for shoulder and seat restraint (EVO QRT) or sky lining (EVO SKY QRT)
- Divisible legrest and seat cushion
- Fixed using M8 lateral fastenings with 290 mm spacing.
Shell weight (g): EVO QRT 5000. EVO SKY QRT 5000
Seat weight (g): EVO QRT 7300. EVO SKY QRT 7300

Code	Colour	Size
008007RNR	Black	Regular
008007RNRSKY	Black Sky	Regular



sparco
EVO L / XL QRT

Homologation: FIA 8855-1999
Material: QRT
Unparalleled comfort and performance
- Self-extinguishing fabric lining
- Non-slip fabric for shoulder and seat restraint
- Divisible legrest and seat cushion
- Fixed using M8 lateral fastenings with 290 mm spacing
Shell weight (g): EVO L QRT 6500. EVO XL QRT 6700
Seat weight (g): EVO L QRT 7700. EVO XL QRT 7900

Code	Colour	Size
008013RNR	Black	Large
008015RNR	Black	Extra Large



sparco
EVO QRT X

HOMOLOGATION: FIA 8855-1999
MATERIAL: QRT
WEIGHT (GR): EVO SHELL QRT X: 5000 / SEAT EVO QRT X: 7300
- Waterproof fabric specific for off-road use.
- Divisible seat and leg rest cushion
- Fixing of M8 side connections with center distance at 290 mm.

Code	Colour	Size
008007XNR	Black	Regular
008013XNR	Black	Large
008015XNR	Black	Extra Large



sparco

GRID Q / GRID Q SKY

Homologation : FIA 8855-1999
 Material: QRT
 Top-level versatility
 - High mobility due to small footprint
 - Customisable padded pads applied with velcro.
 - Self-extinguishing fabric lining (GRID Q) or sky lining (GRID Q SKY)
 - Fixed using M8 lateral fastenings with 290 mm spacing
 Shell weight (g): GRID Q: 5400, GRID Q SKY: 5400
 Seat weight (g): GRID Q: 7300, GRID Q SKY: 7300

Code	Colour	Size
008009RNR	Black	Single size
008009RNRSKY	Black Sky	Single size



sparco

REV QRT

Homologation: FIA 8855-1999
 Material: QRT
 Ultra-compact seat
 - Self-extinguishing fabric lining
 - Non-slip fabric for shoulder and seat restraint
 - Divisible legrest and seat cushion
 - Fixed using M8 lateral fastenings with 290 mm spacing.
 Shell weight (g): 6000
 Seat weight (g): 7100

Code	Colour	Size
008014RNR	Black	Single size



sparco

LEGEND MARTINI RACING

Homologation: FIA 8855-1999
 Original replica of Sparco carbon-kevlar seats used in the 80s on leading rally cars

Code	Colour	Size
008021ZMRBM	Blue	Single size
008021ZMRGR	Grey	Single size



sparco

PRO 2000 QRT MARTINI RACING

Homologation: FIA 8855-1999
 QRT technology seat customized with the iconic Martini Racing livery in the 80's original colors.

Code	Colour	Size
008016RMRBM	Blue	Single size
008016RMRGR	Grey	Single size



PRO 2000 QRT MARTINI RACING WRAP

Homologation: FIA 8855-1999
 QRT technology seat customized with the iconic Martini Racing livery in the 80's original colors. Special customization of the body with Martini Racing livery wrapping.

Code	Colour	Size
008016WRMRBM	Blue	Regular
008016WRMRGR	Grey	Regular



CIRCUIT II MARTINI RACING WRAP

CIRCUIT II QRT seat with special body wrapping covering with Martini Racing livery.
 Approval: FIA8855-1999

Code	Colour	Size
008011WRMRNR	Black	Regular



EVO QRT MARTINI RACING WRAP

EVO QRT seat with special wrapping covering of the body with Martini Racing livery.
 Homologation: FIA 8855-1999

Code	Colour	Size
008007WRMRNR	Black	Regular



SPRINT / L / SKY

With completely revised upholstery, the Sprint seat has a tubular steel frame with an elastic backrest and seat structure. Homologated with holes for bottom and lateral fixing and 5 belt holes. The lateral fastenings have 290 mm spacing. Vinyl version is ideal for off-road vehicles and boats
 Shell weight (g): SPRINT & SPRINT SKY 7940, SPRINT L 10400
 Seat weight (g): SPRINT 9000, SPRINT SKY 9700, SPRINT L 11000
 Homologation: FIA 8855-1999

Code	Colour	Size
008234LAZ	Blue	L
008234LNR	Black	L
008234LRS	Red	L
008235AZ	Blue	Regular
008235NR	Black	Regular
008235NRSKY	Black Sky	Regular
008235RS	Red	Regular

SEATS ACCESSORIES



Mounting Frames

Sparco Seat Mount for ADV SC seat
The ADV SC seat is homologated in conjunction with these brackets.

Code	Description
004982ADV	Sparco Seat Mount for ADV SC seat



Mounting Frames

- Longitudinal distance between holes 290 mm
- 2 symmetrical pieces
- Max length 400 mm
- Simple mounting in the car with more than 25 positions
- 3 mm black powder coated, FIA compliant
- M8 mounting kit included

Code	Description
004902	Sparco Seat Mount steel



Mounting Frames

Sparco Seat Mount for ADV ELITE seat
The ADV ELITE seat is homologated in conjunction with these brackets.

Code	Description
004988ADV	Sparco Seat Mount for ADV ELITE seat



Mounting Frames

- Longitudinal distance between holes 290 mm
- 2 symmetrical pieces
- Max length 415 mm
- Simple mounting in the car with more than 25 positions
- 6 mm anodized aluminium, FIA compliant
- M8 mounting kit included

Code	Description
004903	Sparco Seat Mount alloy



Mounting Frames

Sparco Seat Mount for MASTER seat

Code	Description
004919	Sparco Seat Mount for MASTER seat

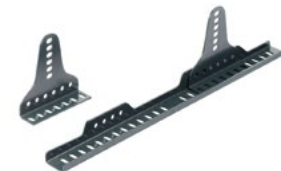

Mounting Frames

- Dismountable mounting frame made of Steel
- Maximum height and length adjustability
- New L shape of the lateral element to allow a double lockage with the base element
- New C shape of the base element to increase the grip of the lateral element
- 22 eyelets on the base element

Code	Description
00492LAT	Sparco Seat Mount



Mounting Frames

Sparco Seat Mount for ADV PRIME 8862 seat

Code	Description
004990ADV	Sparco Seat Mount for ADV PRIME 8862 seat

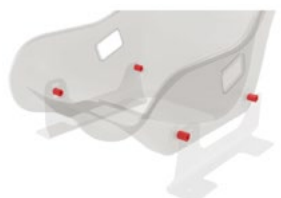

Mounting Frames

Kit of 4 20 mm Nylon spacer bushes for ULTRA seats

Codice	Descrizione
04503	kit of 4 spacers for ULTRA seat



Mounting Frames

- 290 mm spacing
- High resistance steel, 3 mm thick.
- 500 mm length.
- 2 symmetrical pieces.

Code	Description
004915	Sparco Seat Mount steel 500 mm



Drink Bag

Flask carry bag. Insulates from outside heat and keeps drinks at a constant temperature. Holds 1.5 litres, inner bottle and spout also available as spare parts. Four braces for attachment to the seat.

Code	Description
004901NR	Steel seat mount black

Code	Description
01045NR	Sparco In Car Drink System



Mounting Frames

- FIA homologated brackets for ADV SCX, Domex 700 made, adjustable without eyelet, 4 mm thickness.

Code	Description
004985ADV	Sparco Seat Mount for ADV SCX seat
004984ADV	Sparco Seat Mount for ADV SCX-H seat



DUNAFOAM

Two-component polyurethane foam kit suitable for obtaining a rigid foam.
Component 1 - DUNAPOL® C 045 HL Polyol (5 Kg)
Component 2 - DUNAPOL® A 310 Isocyanate (5 Kg)
Expanding agents: CO2
For use, see the technical data sheets in "Download"

Code	Foam amount
DUNAFOAM	5+5 kg

CUSHIONS



sparco

Off road

Code	Size	Colour
01033NR	Low	Black



sparco

Back + bottom padding kit

Codice	Size	Colour
010411PAD3	ULTRA Kit Head and seat	Black - alcantara
010411PAD4	ULTRA Kit Head and seat	Black - fabric



Immagine a solo scopo illustrativo
For illustrative purposes only



sparco

Back + bottom padding kit

Code	Size	Colour
01048KIT8007NR	EVO QRT	Black
01048KIT8007SKY	EVO QRT SKY	Black Sky
01048KIT8009NR	GRID Q	Black
01048KIT8009SKY	GRID Q SKY	Black Sky
01048KIT8011NR	CIRCUIT II	Black
01048KIT8012NR	QRT R	Black
01048KIT8012SKY	QRT R SKY	Black Sky
01048KIT8013NR	EVO L QRT	Black
01048KIT8014NR	REV QRT	Black
01048KIT8015NR	EVO XL QRT	Black
01048KIT8016NR	PRO 2000 QRT	Black
01048KIT8017NR	PRO ADV QRT	Black
01048KIT8018NR	PILOT QRT	Black
01048KIT8019NR	CIRCUIT	Black
01048KIT8025NR	QRT-C	Black



sparco

Back + bottom padding kit

Codice	Size	Colour
010411PAD2	ULTRA Complete kit	Black - fabric
010411PAD1	ULTRA Complete kit	Black - alcantara



sparco

Kidneys lateral cushion

Code	Size	Colour
01022AZ	-	Blue
01022NR	-	Black
01022RS	-	Red



sparco

Leg cushion

Code	Size	Colour
01011AZ	-	Blue
01011NR	-	Black
01011RS	-	Red



sparco

Lateral cushion

Code	Size	Colour
04108009PAD	FIA 8855-1999	Black



sparco

Kidneys central cushion

Code	Size	Colour
01023NR	-	Black



i Customization

Harnesses shown in the catalog are in standard configuration. They can be customized with the components indicated by the manufacturers. For custom configuration contact the Gieffe Racing staff..

Sabelt
Silver Kit Car

- Sabelt 4 point harness FIA 8854/98 approved, shoulder and lap straps 3", aluminium adjusters. Available in 3 colours.
- Shoulder and lap straps: full 3" width
 - Shoulder fixing: snap hook - steel
 - Lap belts: full 3" width – aluminium adjuster Pull Up - snap hook fixing
 - Buckle: Tongues entry designed to simplify the driver fastening. Machined from solid aluminium.
 - Buckle fixed to right lap belt



FIA APPROVED

Codice	Shoulder strap	Lap straps	Hans	Colour
CFCI1118A433SD4F	3"	3"	No	Blue
CFCI2118A433SD4F	3"	3"	No	Black
CFCI4118A433SD4F	3"	3"	No	Red

Sabelt
Steel Kit Car

- Sabelt 4 point harness FIA 8854/98 approved, shoulder and lap straps 3", steel adjusters. Available in 3 colours.
- Shoulder and lap straps: full 3" width
 - Shoulder fixing: Sewn fixing plate - steel
 - Lap belts: full 3" width – steel adjuster Pull Up - snap hook fixing
 - Buckle: Tongues entry designed to simplify the driver fastening. Machined from solid aluminium.
 - Buckle fixed to right lap belt



FIA APPROVED

Codice	Shoulder strap	Lap straps	Hans	Colour
CFCI1118S433SD4F	3"	3"	No	Blue
CFCI2118S433SD4F	3"	3"	No	Black
CFCI4118S433SD4F	3"	3"	No	Red

Sabelt
Steel Four Point

- FIA Harness 4 point 3", steel adjuster.
- Shoulder straps: full 3" width - steel adjuster
 - Shoulder fixing: snap hook - tribar
 - Lap belts: full 3" width – steel adjuster Pull Up - snap hook fixing
 - Buckle fixed to dx lap belt



FIA APPROVED

Codice	Shoulder strap	Lap straps	Hans	Colour
CFCI1118S433SU4F	3"	3"	No	Blue
CFCI2118S433SU4F	3"	3"	No	Black
CFCI4118S433SU4F	3"	3"	No	Red

sparco
SPORT H-4

- Homologation: FIA 8854-1998
Ultra-light adjusters in high-strength steel, aluminium buckle, snap-hook fastenings, polyester ribbon.



FIA APPROVED

Code	Shoulder strap	Lap straps	Hans	Colour
04716M1AZ	3"	2"	No	Blue
04716M1NR	3"	2"	No	Black
04716M1RS	3"	2"	No	Red

SINGLE SEATER HARNESSES

Sabelt
Gold Superformula 8

Sabelt 8 points harnesses FIA 8853-2016 approved
 - Shoulder straps: 2" + 3" width - superlight quick release CNC adjusters - Shoulder fixing: "Sewn loop" fixing - Lap belts and crotches: full 2" width - Titanium double fixing plate - "Formula 1" ultralight buckle



FIA APPROVED

Codice	Shoulder strap	Lap straps	Crotch straps	Hans	Colour
CFCI1397G832FU6F	2"	2"	2"	Yes	Blue
CFCI2397G832FU6F	2"	2"	2"	Yes	Black
CFCI4397G832FU6F	2"	2"	2"	Yes	Red

Sabelt
Gold Superformula 6

Harnesses specific hans with shoulder straps 2"+3", waist straps 2", crutch straps 2". 8 fixing point. Quick release adjuster machined from solid aluminium 74gr. Superlight buckle in machined from solid aluminium developed with F1 Teams Approval : FIA 8853-2016



FIA APPROVED

Codice	Shoulder strap	Lap straps	Crotch straps	Hans	Colour
CFCI1393G622FU6F	2"	2"	2"	Yes	Blue
CFCI2393G622FU6F	2"	2"	2"	Yes	Black
CFCI4393G622FU6F	2"	2"	2"	Yes	Red

Sabelt
Silver Formula

Sabelt 6 points harnesses FIA 8853-2016 approved
 - Shoulder straps: 2" width - superlight quick release CNC adjusters - Lap belts 2" - steel-aluminium adjusters - Crotches 2" width - "Formula" aluminium buckle



FIA APPROVED

Codice	Shoulder strap	Lap straps	Crotch straps	Hans	Colour
CFCI1350A622FU3F6	2"	2"	2"	Yes	Blue
CFCI2350A622FU3F6	2"	2"	2"	Yes	Black
CFCI4350A622FU3F6	2"	2"	2"	Yes	Red

Sabelt
Steel Formula Basic

6 piont FIA Harness 2", lightweight aluminium adjusters.
 - Shoulder straps: full 2" width - aluminum lightweight adjuster - Shoulder fixing: plate - tribar
 - Lap belts: full 2" width - steel/aluminum adjuster Pull Up - plate fixing - New compact buckle
 - Crotches: "formula" type 2" width - plate / tribar fixing



FIA APPROVED

Codice	Shoulder strap	Lap straps	Crotch straps	Hans	Colour
CFCI1350S622FU3F6	2"	2"	2"	Yes	Blue
CFCI2350S622FU3F6	2"	2"	2"	Yes	Black
CFCI4350S622FU3F6	2"	2"	2"	Yes	Red

Sabelt
Steel Formula Mid

Sabelt 6 points harnesses FIA 8853-2016 approved
 - Shoulder straps: 2" width - superlight quick release CNC adjusters - Lap belts 2" - steel-aluminium adjusters - Crotches 2" width - "Formula" aluminium buckle



FIA APPROVED

Codice	Shoulder strap	Lap straps	Crotch straps	Hans	Colour
CFCI13500064	2"	2"	2"	Yes	Blue
CFCI23500064	2"	2"	2"	Yes	Black
CFCI43500064	2"	2"	2"	Yes	Blue

sparco
FORMULA H-10

Homologation: FIA 8853-2016. Specific Hans belt (2" suit), titanium adjusters, titanium full release buckle, Sparco motif, dogbone fastening (screw fastening on request), ultra-light hybrid ribbon, weight 500 grams.



FIA APPROVED

Code	Shoulder strap	Lap straps	Crotch straps	Hans	Colour
04822HNR	2"	2"	2"	Yes	Black

SINGLE SEATER HARNESSES

sparco
FORMULA H-9

2" hans 6-point harness for single-seater cars. F1 shoulder straps. F1 aluminum adjusters. Aluminum buckle with fixed point on the lap. Screw fastening with double adjustable tab.



Code	Shoulder strap	Lap straps	Crotch straps	Hans	Colour
04833H	2"	2"	2"	Yes	Black

sparco
FORMULA H-8

6-point seat belt for single-seater. 2" specific HANS straps. Aluminium buckle with short lever. Aluminium adjusters only on shoulder straps. Abdominal and thigh branches without adjustment for maximum lightness. Fixings: shoulder straps with sewn loop for dog bone, abdominal and thigh straps with double tongue for adjustment and stainless steel bushing for fixing with 8.5 mm diameter screw. FIA APPROVED 8853-2016



Code	Shoulder strap	Lap straps	Crotch straps	Hans	Colour
04823HNR	2"	2"	2"	Yes	Black

sparco
FORMULA H-7

6-point seat belt for single-seater. 2" specific HANS straps. Aluminium buckle. Steel adjusters on shoulder and abdominal straps. Triangle screw fixings, 13 mm diameter hole, roll-cage or dog bone mounting possible by eliminating triangles. FIA APPROVED 8853-2016



Code	Shoulder strap	Lap straps	Crotch straps	Hans	Colour
04819H2AZ	2"	2"	2"	Yes	Blue
04819H2NR	2"	2"	2"	Yes	Black
04819H2RS	2"	2"	2"	Yes	Red



6 POINTS TOURING

Sabelt
Steel Rally 2X2

6 points FIA harness 2", steel adjusters
 - Shoulder straps: full 2" width - steel adjuster
 - Shoulder fixing: snap hook - tribar
 - Lap belts: full 2" width - steel adjuster Pull Up - snap hook fixing
 - New compact buckle designed with crotches slots integrated to main body
 - Crotches: 2" width - snap hook / tribar fixing



Codice	Shoulder strap	Lap straps	Crotch straps	Hans	Colour
CFCI1210S622SU2F	2"	2"	2"	Yes	Blue
CFCI2210S622SU2F	2"	2"	2"	Yes	Black
CFCI4210S622SU2F	2"	2"	2"	Yes	Red

Sabelt
Gold Endurance

Hans harnesses Shoulder Straps 2", waist straps 2", crutch straps 2". 6 fixing point Adjuster with webbing guide - Aluminium quick adjuster 2" with webbing guide. 2019 24hLe Mans winner. Ergal "Tribar" adjuster for 2" webbing. Steel.



Codice	Shoulder strap	Lap straps	Crotch straps	Hans	Colour
CFCI1428G632SD7F	2"	2"	2"	No	Blue
CFCI2428G632SD7F	2"	2"	2"	No	Black
CFCI4428G632SD7F	2"	2"	2"	No	Red

Sabelt
Silver LPM

- FIA 8853-2016 approved
- Shoulder straps: full 2" width - superlight quick release adjuster
- Shoulder fixing: Snap hook with Tribar® adjuster
- Lap belts: 2" Carabiner fixing - Lap strap tongue with integrated adjuster for 2" width web-bing. Steel. 2021 24h Le Mans winner. 113 g.
- Tongues entry designed to simplify the driver fastening. Quick release with spring ejectors.
- Crotches: 2" width - snap hook / tribar fixing
- Yellow loops - Velcro on shoulder straps - Intercom cord



Codice	Shoulder strap	Lap straps	Crotch straps	Hans	Colour
CFCI12170068	2"	2"	2"	Yes	Blue
CFCI22170068	2"	2"	2"	Yes	Black
CFCI42170068	2"	2"	2"	Yes	Red

Sabelt
Silver Rally

- 6 points FIA harness 2", lightweight aluminium adjuster
- Shoulder straps: full 2" width - aluminum lightweight adjuster
- Shoulder fixing: snap hook - tribar
- Lap belts: full 2" width - aluminum lightweight adjuster Pull Up - snap hook fixing
- New compact buckle designed with crotches slots integrated to main body
- Crotches: 2" width - snap hook / tribar fixing



Codice	Shoulder strap	Lap straps	Crotch straps	Hans	Colour
CFCI1210A622SU2F	2"	2"	2"	Yes	Blue
CFCI2210A622SU2F	2"	2"	2"	Yes	Black
CFCI4210A622SU2F	2"	2"	2"	Yes	Red

Sabelt
Silver Endurance

- FIA 8853-2016 approved
- Shoulder straps: full 2" width - aluminum lightweight adjuster
- Shoulder fixing: snap hook - tribar
- Lap belts: full 2" width - lightweight carabinas, 2" quick adjuster integrated to buckle tongue - Pull Down. Designed for GT/ Endurance
- Buckle with integrated crotch belt "T" type attachment. Aluminium. Patented buckle
- Crotches: 2" width - snap hook / tribar fixing
- Yellow loops - Velcros on shoulders - Intercom cord



Codice	Shoulder strap	Lap straps	Crotch straps	Hans	Colour
CFCI1210A622SD2F	2"	2"	2"	Yes	Blue
CFCI2210A622SD2F	2"	2"	2"	Yes	Black
CFCI4210A622SD2F	2"	2"	2"	Yes	Red

Sabelt
Silver Rally 3X3

- 6 points FIA harness 3", lightweight aluminium adjuster
- Shoulder straps: full 3" width - aluminum lightweight adjuster
- Shoulder fixing: snap hook - tribar
- Lap belts: full 3" width - aluminum lightweight adjuster Pull Up-snap hook fixing
- New compact buckle designed with crotches slots integrated to main body
- Crotches: 2" width - snap hook / tribar fixing



Codice	Shoulder strap	Lap straps	Crotch straps	Hans	Colour
CFCI1335A633SU2F	3"	3"	2"	No	Blue
CFCI2335A633SU2F	3"	3"	2"	No	Black
CFCI4335A633SU2F	3"	3"	2"	No	Red



Sabelt
Steel Rally 3X2

6 points FIA harness 3", steel adjuster
- Shoulder straps: full 3" width - steel adjuster - Shoulder fixing: snap hook - tri-bar - Lap belts: full 2" width - snap hook - Lap belts: 2" quick adjuster integrated to buckle tongue - Pull Down. Designed for GT/Endurance - New compact buckle designed with crotches slots integrated to main body
- Crotches: 2" width - snap hook / tri-bar fixing



Codice	Shoulder strap	Lap straps	Crotch straps	Hans	Colour
CFCI1335S6332D2F	3"	2"	2"	No	Blue
CFCI2335S632SD2F	3"	2"	2"	No	Black
CFCI4335S632SD2F	3"	2"	2"	No	Red

Sabelt
Steel Rally 3X3

6 points FIA harness 3", steel adjuster.
- Shoulder straps: full 3" width - steel adjuster - Shoulder fixing: snap hook - tri-bar - Lap belts: full 3" width - steel adjuster Pull Up - snap hook fixing - New compact buckle designed with crotches slots integrated to main body - Crotches: 2" width - snap hook / tri-bar fixing



Codice	Shoulder strap	Lap straps	Crotch straps	Hans	Colour
CFCI1335S6333SU2F	3"	3"	2"	No	Blue
CFCI2335S6333SU2F	3"	3"	2"	No	Black
CFCI4335S6333SU2F	3"	3"	2"	No	Red

sparco
PRO H-9

6 point harness. 2" FHR specific straps. Compact T-bar. Aluminium buckle. Aluminium adjusters Rollcage fasteners (shoulders and thigh) and ultra-light karabiner (abdominal).
HOMOLOGATION FIA 8853-2016



Code	Shoulder strap	Lap straps	Crotch straps	Hans	Colour
04825HNR	2"	2"	2"	Yes	Black
04825HRS	2"	2"	2"	Yes	Red

sparco
COMPETITION H-2 PU

6-point harness. 2" FHR Shoulder straps - Aluminum buckle - PULLDOWN abdominal adjustment with integrated tongue - 2" straps with steel adjuster - Snap-on for all straps. FIA APPROVED 8853-2016



Codice	Shoulder strap	Lap straps	Crotch straps	Hans	Colour
04821H1AZ	2"	2"	2"	Yes	Blue
04821H1NR	2"	2"	2"	Yes	Black
04821H1RS	2"	2"	2"	Yes	Red

sparco
COMPETITION H-2 PD

6 point harness. 2" FHR specific straps. - Aluminium buckle. - High resistance steel adjusters. - Pull down adjustment on abdominals. - Snap hooks. - Compact T-bar. HOMOLOGATION: FIA 8853-2016



Code	Shoulder strap	Lap straps	Crotch straps	Hans	Colour
04834HPDAZ	2"	2"	2"	Yes	Blue
04834HPDNR	2"	2"	2"	Yes	Black
04834HPDRS	2"	2"	2"	Yes	Red

sparco
COMPETITION H-3 STEEL

6-point harness. 2" FHR Shoulder straps - Compact T-bar - Aluminium buckle - Steel adjusters - Snap-on for all straps. FIA APPROVED 8853-2016



Codice	Shoulder strap	Lap straps	Crotch straps	Hans	Colour
04834HPDRACAZ	3"	3"	2"	No	Blue
04834HPDRACNR	3"	3"	2"	No	Black
04834HPDRACRS	3"	3"	2"	No	Red

sparco
COMPETITION H-3+2

6-point seat belt
3" specific HANS shoulder straps with reduction to 2".
Aluminium buckle.
Steel shoulder and abdominal strap adjusters.
Pull-up adjustment on abdominal straps.
Snap-hook fasteners on all branches
Possibility of roll-cage fixing on shoulder and thigh straps.
FIA APPROVED 8853-2016



Code	Shoulder strap	Lap straps	Crotch straps	Hans	Colour
04818RH1AZ	3"-2"	3"	2"	Yes	Blue
04818RH1NR	3"-2"	3"	2"	Yes	Black
04818RH1RS	3"-2"	3"	2"	Yes	Red

sparco
PRO H-8 ENDURANCE

6-point FHR Endurance harness. 2" FHR specific strap - Aluminum buckle. - Aluminum adjuster on shoulder strap - Steel adjuster on thigh and abdominal - Pull up adjustments - Screw fixings on all branches - Roll-bar fixing for shoulder and crotch straps. FIA 8853-2016 HOMOLOGATION



Code	Shoulder strap	Lap straps	Crotch straps	Hans	Colour
04835HNR	2"	2"	2"	Yes	Black



sparco
H-9 EVO MARTINI RACING

6 point harness with Martini Racing jacquard patches. 2" FHR specific straps. Compact T-bar Aluminium buckle. Aluminium adjusters
Rollcage fasteners (shoulders and thigh) and ultra-light karabiner (abdominal).
HOMOLOGATION FIA 8853-2016



Code	Shoulder strap	Lap straps	Crotch straps	Hans	Colour
04825HMRNR	2"	2"	2"	Yes	Black
04825HMRRS	2"	2"	2"	Yes	Red

sparco
04834HPD MARTINI RACING

HOMOLOGATION: FIA 8853-2016. 6 point harness with Martini Racing jacquard patches
2" FHR specific straps. Aluminium buckle. High resistance steel adjusters. Pull down adjustment on abdominals. Snap hooks. Compact T-bar.



Code	Shoulder strap	Lap straps	Crotch straps	Hans	Colour
04834HPDMRAZ	2"	2"	2"	Yes	Blue
04834HPDMRNR	2"	2"	2"	Yes	Black
04834HPDMRRS	2"	2"	2"	Yes	Red

HARNESSES ACCESSORIES



sparco
Miscellaneous Accessories

Code	Description
04501	Harness Eyebolt



sparco
Miscellaneous Accessories

Code	Description
04502	Harness Bolt Plate



014777EXP
 HOMOLOGATION: FIA 8865-2015
 Pressurised extinguisher system, FIA8865-2015 approved
 - Electrical activation
 - 4,3 kg of extinguisher agent FK-5-1-12.
 - 3,9l Stainless steel tank (Ø130 x 346 mm).
 - 1 interior nozzle + 1 motor nozzle.
 - For cockpits with volumes from 2.3m³ - 4.1m³.
 All components required for correct installation included in the kit.

Code	Activation	Capacity	Bottle	Dimensions
014777EXP	Electric	2,0 Lt	Steel	Ø 160 x 235 mm

Kit



MA0142131 MA0142098	MA0142107	MA0142108	MA0142109	MA0142117	MA0142122	MA0142127	MA0142128 MA0142129	MA0142133	MA0142134	MA0142135	MA0142023	MA0142163
------------------------	-----------	-----------	-----------	-----------	-----------	-----------	------------------------	-----------	-----------	-----------	-----------	-----------



014779EXP
 HOMOLOGATION: FIA 8865-2015
 - FIA homologated pressurised extinguishing system (8865-2015).
 - 3.3 Kg of FK-5-1-12 extinguishing agent.
 - Electrical activation.
 - 2.5l stainless steel tank with 114mm diameter.
 - Length 302 mm.
 - 1 interior nozzle + 1 motor nozzle.
 - For cockpits with volumes from 1.2 m³ - 2.3 m³.

Code	Activation	Capacity	Bottle	Dimensions
014779EXP	Electric	2,5 Lt	Steel	Ø 114 x 302 mm

Kit

014779EXP



MA0142145 MA0142082	MA0142107	MA0142109	MA0142117	MA0142122	MA0142127	MA0142128 MA0142129	MA0142133	MA0142134	MA0142135	MA0142023	MA0142163
------------------------	-----------	-----------	-----------	-----------	-----------	------------------------	-----------	-----------	-----------	-----------	-----------



SP 205 & 305
 Ultralight, electrically operated extinguishing system.
 HOMOLOGATION: FIA 2000
 - 2.5l (014778EXL2) or 3.9l (014778EXL3) stainless steel tank
 - AFFF extinguishing agent (2l for 014778EXL2 or 3l for 014778EXL3).
 - Billet nozzles.
 - Full metal fittings.

Code	Activation	Capacity	Bottle	Dimensions
014778EXL2	Electric	2,5 Lt	Steel	Ø 110 x 302 mm
014778EXL3	Electric	3,9 Lt	Steel	Ø 130 x 346 mm

Kit



014778EXL2	MA0142103 MA0142082	MA0142029	MA0142163	MA0142023	MA0142030	MA0142043	MA0142041	MA0142042	MA0142040
014778EXL3	MA0142131 MA0142098	MA0142029	MA0142163	MA0142023	MA0142030	MA0142043	MA0142041	MA0142042	MA0142040



This electrically operated Multi-Flo extinguisher system is designed specifically for all single seater car applications requiring a FIA Technical list 16 system. The 0,9 Liters capacity foam based extinguishant is dispensed evenly to both the engine bay and cockpit via 6 specially designed nozzles to give fast knock down and fire out times. The kit supplied offers all parts needed to fit and operate. FIA 2000 Approved

Code	Activation	Capacity	Bottle	Dimensions
014772FEAL	Electric	1,3 Lt	Aluminium	Ø 106 x 188 mm

Kit



MA0142083 MA0142082	MA0142029	MA0142163	MA0142023	MA0142030	MA0142043	MA0142041	MA0142042	MA0142040
------------------------	-----------	-----------	-----------	-----------	-----------	-----------	-----------	-----------



FIA 2000 APPROVED
Ultra-light, electrically activated extinguisher system. CE certified bottle in stainless steel (tested at over 40 Bar), AFFF foam extinguisher (4.25 litres), solid block-machined nozzles, all-metal connectors.

Code	Activation	Capacity	Bottle	Dimensions
014772EXL	Electric	4,25 Lt	Steel	380 x Ø 160 mm

Kit



MA0142013 MA0142049 MA01480	MA0142029	MA0142163	MA0142023	MA0142030	MA0142043	MA0142041	MA0142042	MA0142040
-----------------------------------	-----------	-----------	-----------	-----------	-----------	-----------	-----------	-----------



FIA 2000 APPROVED
Mechanically activated extinguisher system. CE certified bottle in steel (tested at over 40 Bar), AFFF foam extinguisher (4.25 litres), solid block-machined nozzles, all-metal connectors.

Code	Activation	Capacity	Bottle	Dimensions
014772MSL	Mechanical	4,25 Lt	Steel	380 x Ø 160 mm

Kit



MA0142013 MA0142049 MA01480	MA0142029	MA014RL24CL	MA0142023	MA0142043	MA0142041	MA0142042	MA0142040
-----------------------------------	-----------	-------------	-----------	-----------	-----------	-----------	-----------



106-001-011

106-001-012

- Kit includes:
- 8mm – Alloy Semi Rigid Tube – 6m Length (951-101-014) x 1
 - Heat Proof Overbraid – 6m (951-300-002) x 1
 - 2.0mtr/6ft Pull Cable – Red T Handle (935-100-001) x 1
 - 4.0mtr/12ft Pull Cable – Red T Handle (935-100-002) x 1
 - Zero 2020 Brackets & Straps (920-100-054) x 1
 - Decal Pack (990-100-001) x 1
 - 8mm Bulkhead Fitting (952-408-002) x 1
 - Misting Nozzle (955-300-015) x 5
 - 8mm Equal T Connector (952-408-001) x 4

Lifeline
Fire & Safety Systems Ltd
Lifeline Zero2020

2022 marks the beginning of a new era for Lifeline, after over 25 years of continuous service the Zero 2000 range of plumbed in extinguishers is replaced by Zero 2020. Delivering on Lifeline's core engineering principles the new Zero 2020 range is smaller and lighter than its predecessor while still delivering increased levels of safety to competitors. Bringing new water based suppressant technology to the motorsports arena and challenging well established traditions, moving competitors safety to another level. Lifeline's leading misting nozzle technology has the fastest heat absorption and fire knock down capability available from a water based system. Supplied with a comprehensive installation kit the system utilises three nozzles in the engine bay and two in the cockpit. This further reduces weight and complexity of the installation meaning every level of racer has access to the lightest and best technology on the market.

Compliant with the FIA Technical list 16 the Zero 2020 range covers competitors for the 2022 MSUK rule change and it's lightweight and compact design make it suitable for use in a wide range of vehicles including:

- Saloon Cars
- Sports Cars
- Rally Cars (the 3.0ltrs capacity of the system meets the FIA/MSUKs minimum requirements for rallying)
- Single Seaters

Code	Activation	Capacity	Bottle	Dimensions
106-001-011	Mechanical	3,0 Lt	Steel	155 Ø x 342 mm
106-001-012	Electric	3,0 Lt	Aluminium	155 Ø x 238 mm



Lifeline
Fire & Safety Systems Ltd
Lifeline Zero EV

The Zero EV is lifeline first Novec only 8865-2015 system. The Novec suppressant is non-conductive which means that it is the perfect solution for Hybrid and electric vehicles, Bio fuels as well as petrol vehicles.

Weight 5.6kg and is to be used in a cockpit volume up to 3.13cm3.

Kit contains: retaining straps and brackets FIA, Plug & lead - binder 2 pin, Polyamide coated aluminium tube (6m x 10mm , 3m x 8mm), Activation kit FIA 8865, control box FIA 8865, 2 switch-pushbutton, binder 4 core M8 lead 2m, 1 x 10mm equal T connector, 2 x 10mm male to 8mm female reducers, 2 nozzle twin slot 8 mm, 1 nozzle petal 10mm, 2 reusable cable ties 200 x 7,5mm, decal pack, Cylinder service advice note, Installation guide, ancillaries.

Code	Activation	Capacity	Bottle	Dimensions
105-001-020	Remote	3,8 Kg	Aluminium	127 Ø x 330 mm



Lifeline
Fire & Safety Systems Ltd
Lifeline Zero275

Lifeline continues its market leading development of the FIA's 8865-2015 standard and has launched the lightest and most compact 8865-2015 extinguisher system currently available, Zero 275. The full system including all ancillaries weighs under 3.5kgs, the compact filled cylinder weighs just 2.6kg and is 125mm in diameter and has a total length of 308mm making it simple to install, easy to package and lightweight.

During the development, Lifeline has employed the use of advanced fluid dynamics analysis to make a significant step forward in driver safety. As a result the suppressant is efficiently used, allowing the nozzle to be floor mounted, which aids in lowering the vehicles overall centre of gravity. In the engine bay, 3 outlets and the use of new materials account for a significant reduction in suppressant volume when compared to previous 8865-2015 systems. The efficient design of the system and intelligent use of materials, makes the cost of an 8865 system comparable to Technical list 16 systems. Utilising feedback gained from many of the world's leading constructors, Lifeline has developed a simple installation kit and electronic control system making the Zero 275 is perfect for competitors who are looking to save weight, cost, complexity and packaging with increased fire protection in comparison to the previous generations of 8865 systems.

Code	Activation	Capacity	Bottle	Dimensions
105-001-019	Electric	0-4 m3	Aluminium	125 Ø x 308 mm

- Kit Includes
- Floor Mounted Cockpit Nozzle - 955-300-025 x 1, Engine Bay Nozzles - 955-300-013 x 3
 - FIA compliant Bracket and Straps - 920-100-008-FIA x 1
 - Tubing, 10mm Dia in Cockpit - 951-101-021, 8mm Dia in engine - 951-101-019
 - Cross Connector - 952-408-007 x 1, Intelligent Control Box - 941-000-040 x 1,
 - Waterproof switches - 942-100-004 x 2, Wiring For switches 943-101-005 x 2 and Control Box 943-101-044 x 1



lifeline
Fire & Safety Equipment Ltd

Lifeline Zero360

FIA approved, using undiluted Novec 1230 gas, 1,5 - 2,0 - 2,25 or 3,0 kg aluminium or steel bottle. Electrical, mechanical or remote discharge.

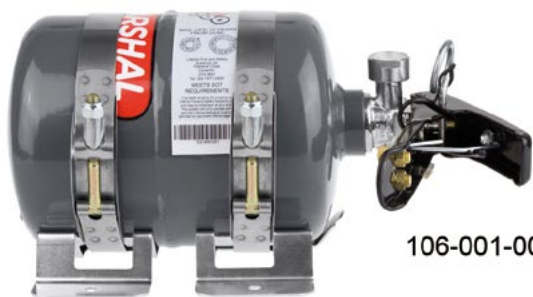

106-001-004

106-001-004 - Lifeline Zero 360 Fire Marshal Mechanical 2,25 Kg: steel bottle, heat proof overbraid 6-10 mm (6 mt), FIA retaining strap (920-100-008-FIA), decal pack (990-100-001 x 1), 8 mm alloy semi-rigid tube (951-101-008 x 6m), 2.0 mt pull cable red T handle (935-100-001 x 1), 4.0 mt pull cable red T handle (935-100-002 x 1), packet of tube clips (fit all sizes - 951-200-004), Zero 360 double "Z" nozzle (955-300-004 x 3), Zero 360 nozzle (955-300-003 x 2), 8 mm 4 way equal cross connector (952-408-007 x 1), 8 mm equal T connector (952-408-001 x 1), 8 mm bulkhead connector (952-408-002 x 1).



106-001-005

106-001-005 - Lifeline Zero 360 Stored Pressure Electric 2,25 Kg: aluminium bottle, heat proof overbraid 6-10 mm (6 mt), FIA retaining strap (920-100-008-FIA), decal pack (990-100-001 x 1), 8 mm alloy semi-rigid tube (951-101-008 x 6m), spacket of tube clips (fit all sizes - 951-200-004), Zero 360 double "Z" nozzle (955-300-004 x 3), Zero 360 nozzle (955-300-003 x 2), 8 mm 4 way equal cross connector (952-408-007 x 1), 8 mm equal T connector (952-408-001 x 1), 8 mm bulkhead connector (952-408-002 x 1), Power pack - current - DIN socket (941-000-001 x 1), plug & lead assembly - standard (2 pc), internal/external waterproof aluminium switch (942-100-004 x 2).



106-001-007

106-001-007 - Lifeline Zero 360 Fire Marshal Mechanical 3,0 Kg: steel bottle, heat proof overbraid 6-10 mm (6 mt), FIA retaining strap (920-100-008-FIA), decal pack (990-100-001 x 1), 8 mm alloy semi-rigid tube (951-101-008 x 6m), 2.0 mt pull cable red T handle (935-100-001 x 1), 4.0 mt pull cable red T handle (935-100-002 x 1), packet of tube clips (fit all sizes - 951-200-004), Zero 360 double "Z" nozzle (955-300-004 x 3), Zero 360 nozzle (955-300-003 x 2), 8 mm 4 way equal cross connector (952-408-007 x 1), 8 mm equal T connector (952-408-001 x 1), 8 mm bulkhead connector (952-408-002 x 1).



106-001-008

106-001-008 - Lifeline Zero 360 Stored Pressure Electric 3,0 Kg con: aluminium bottle, heat proof overbraid 6-10 mm (6 mt), FIA retaining strap (920-100-008-FIA), decal pack (990-100-001 x 1), 8 mm alloy semi-rigid tube (951-101-008 x 6m), spacket of tube clips (fit all sizes - 951-200-004), Zero 360 double "Z" nozzle (955-300-004 x 3), Zero 360 nozzle (955-300-003 x 2), 8 mm 4 way equal cross connector (952-408-007 x 1), 8 mm equal T connector (952-408-001 x 1), 8 mm bulkhead connector (952-408-002 x 1), Power pack - current - DIN socket (941-000-001 x 1), plug & lead assembly - standard (2 pc), internal/external waterproof aluminium switch (942-100-004 x 2).

106-001-003 - Lifeline Zero 360 Remote Charge 1,5 Kg: aluminium bottle, heat proof overbraid 6-10 mm (6 mt), FIA retaining strap (920-100-019-FIA), decal pack (990-100-001 x 1), 8 mm alloy semi-rigid tube (951-101-008 x 6m), packet of tube clips (fit all sizes - 951-200-004), Zero 360 double "Z" nozzle (955-300-004 x 2), Zero 360 nozzle (955-300-003 x 2), 8 mm 4 way equal cross connector (952-408-007 x 1), 8 mm equal T connector (952-408-001 x 1), 8 mm bulkhead connector (952-408-002 x 1), Control Box - 941-000-001 x 1), internal/external waterproof aluminium switch (942-100-004 x 2), saddle & ty rap for remote charge (1 pc).

106-001-006 - Lifeline Zero 360 Remote Charge 2,0 Kg: aluminium bottle, heat proof overbraid 6-10 mm (6 mt), FIA retaining strap (920-100-007-FIA), decal pack (990-100-001 x 1), 8 mm alloy semi-rigid tube (951-101-008 x 6m), packet of tube clips (fit all sizes - 951-200-004), Zero 360 double "Z" nozzle (955-300-004 x 2), Zero 360 nozzle (955-300-003 x 2), 8 mm 4 way equal cross connector (952-408-007 x 1), 8 mm equal T connector (952-408-001 x 1), 8 mm bulkhead connector (952-408-002 x 1), Control Box - 941-000-001 x 1), internal/external waterproof aluminium switch (942-100-004 x 2), saddle & ty rap for remote charge (1 pc).

106-001-009 - Lifeline Zero 360 Remote Charge 3,0 Kg: aluminium bottle, heat proof overbraid 6-10 mm (6 mt), FIA retaining strap (920-100-007-FIA), decal pack (990-100-001 x 1), 8 mm alloy semi-rigid tube (951-101-008 x 6m), packet of tube clips (fit all sizes - 951-200-004), Zero 360 double "Z" nozzle (955-300-004 x 2), Zero 360 nozzle (955-300-003 x 2), 8 mm 4 way equal cross connector (952-408-007 x 1), 8 mm equal T connector (952-408-001 x 1), 8 mm bulkhead connector (952-408-002 x 1), Control Box - 941-000-001 x 1), internal/external waterproof aluminium switch (942-100-004 x 2), saddle & ty rap for remote charge (1 pc).

Code	Activation	Capacity	Bottle	Dimensions
106-001-003	Remote	1,5 Kg	Aluminium	90 Ø x 230 mm
106-001-004	Mechanical	2,25 Kg	Steel	125 Ø x 270 mm
106-001-005	Electric	2,25 Kg	Aluminium	125 Ø x 235 mm
106-001-006	Remote	2,0 Kg	Aluminium	108 Ø x 219 mm
106-001-007	Mechanical	3,0 Kg	Steel	125 Ø x 324 mm
106-001-008	Electric	3,0 Kg	Aluminium	125 Ø x 297 mm
106-001-009	Remote	3,0 Kg	Aluminium	108 Ø x 274 mm



106-001-003



106-001-006



106-001-009

HAND HELD



sparco
014773BSS2



sparco
014773BXLN2



sparco
014773BXL24

Code	Capacity	Bottle	Extinguishant	Note
014773BSS2	2,0 l	Steel	EN3 Powder	SPECIAL SHIPPING ("hazardous goods")
014773BXLN2	2,0 l	Inox	Novec	SPECIAL SHIPPING ("hazardous goods")
014773BXL24	2,4 l	Inox	AFFF	SPECIAL SHIPPING ("hazardous goods")



lifeline
Fire & Safety Systems Ltd
Zero 360 Hand Held

Smaller and lighter than their Zero 2000 (AFFF) counterparts, the Zero 360 fire extinguishers use a Novec™ 1230 gas as suppressor. At the time of unloading, the suppressor works in a three-dimensional way to fill the area to be protected. This means that it can effectively extinguish a fire that is not in the direct line of the nozzle and represents the "gold standard" of fire suppression. FIA compliant.

Code	Capacity	Bottle	Extinguishant	Note
207-101-001	1,0 l	Aluminium	Novec 1230	SPECIAL SHIPPING ("hazardous goods")
207-101-003	3,0 l	Aluminium	Novec 1230	SPECIAL SHIPPING ("hazardous goods")
207-101-002	2,0 l	Aluminium	Novec 1230	SPECIAL SHIPPING ("hazardous goods")



lifeline
Motor Sport AFFF

Lifeline hand held AFFF (Aqueous Film Forming Foam) extinguishers from 1,0 to 2,4 Litres, supplied complete with a bracket and quick release strap for easy access (except for belt mount units). All units have a 2 year servicing cycle.

Code	Capacity	Bottle	Extinguishant	Note
201-100-001	1,0 Lt	Steel	AFFF Foam	SPECIAL SHIPPING ("hazardous goods")
201-100-002	1,75 Lt	Steel	AFFF Foam	SPECIAL SHIPPING ("hazardous goods")
201-100-003	2,4 Lt standard	Steel	AFFF Foam	SPECIAL SHIPPING ("hazardous goods")



Always check the fire extinguishers!



Safety is fundamental. Never to compromise and rely only on good luck. When you need your fire extinguishing system must totally fulfill his duty. Always check the system pressure and make the necessary revisions. Not only for the regulation, but especially for your safety.

We remind you that the bottles with more than 10 years (date of construction) can not be revised, but must be replaced.

RACE AND RALLY STEERING WHEEL



F-10 C

Carbon steering wheel for prototype single-seater and sports vehicle. Ergonomic grip, designed based on experience gained with the racing teams of the most prestigious motor manufacturers. Hole interaxis 3x50.8 mm. Diameter 270 mm. Suede



Code	Material
015PC270SSN	Suede



P 310

Sparco steering wheel Ø 310mm diameter, flat steering wheel ideal for GT car. Hole interaxis: 6 x 70 mm



Code	Material
015P310F2SN	Suede



R 330B

Sparco steering wheel Ø 330 mm with buttons. Suede. Hole interaxes: 6 x 70 mm



Code	Material
015R330PSO	Suede



F-10 A

Aluminium steering wheel for prototype single-seater and sports vehicle. Ergonomic grip, designed based on experience gained with the racing teams of the most prestigious motor manufacturers. Hole interaxis 3x50.8 mm. Diameter 270 mm. Suede



Code	Material
015P270SSN	Suede



P 300

Sparco steering wheel Ø 300mm in black suede. Hole interaxis: 6 x 70 mm

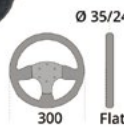

Code	Material
015P300SN	Suede



R 350

Sparco steering wheel Ø 350 mm without buttons. Suede or leather. Hole interaxes: 6 x 70 mm



Code	Material
015R350CLO	Leather
015R350CSO	Suede



P 310 OPEN

Sparco Ø 310mm suede steering wheel
- Open top, ideal for GT cars.
- Hole spacing: 6 x 70 mm



Code	Material
015P310OPN	Suede



R 330

Sparco steering wheel Ø 330 mm without buttons. Suede or leather. Hole interaxes: 6 x 70 mm



Code	Material
015R330CLO	Leather
015R330CSO	Suede



R 350B

Sparco steering wheel Ø 350 mm with buttons. Suede. Hole interaxes: 6 x 70 mm



Code	Material
015R350PSO	Suede

RACE AND RALLY STEERING WHEEL



Sparco steering wheel Ø 330mm, in black suede.
Hole interaxis: 6 x 70 mm



Code	Material
015R323PSNR	Suede



Sparco steering wheel Ø 350mm, special 36 mm dished, trimmed in black suede.
Hole interaxis: 6 x 70 mm



Code	Material
015R375PSN	Suede



SPARCO Ø 350mm flat steering wheel, for Rally use in suede.
Hole spacing: 6 x 70 mm



Code	Material
015R215FL	Leather
015R215FS	Suede



Sparco steering wheel Ø 330mm, flat bottomed, trimmed in black suede. Large grip.
Hole interaxis: 6 x 70 mm



Code	Material
015R353PSN	Suede



Sparco steering wheel Ø 350mm, semi dish steering wheel available in leather or suede.
Hole interaxis: 6 x 70 mm



Code	Material
015R345MLN	Leather
015R345MSN	Suede



Sparco steering Ø 350mm diameter, 3 spoke full dish with small grip.
Available in suede.
Hole interaxis: 6 x 70 mm



Code	Material
015R325CSN	Suede



Sparco steering wheel Ø 330mm trimmed in black suede. Special comfortable grip shape. Hole interaxis: 6 x 70 mm.
015R383PSNLOGO: with blue central reference ring with printed logo



Code	Material
015R383PSN	Suede
015R383PSNLOGO	Suede with blue refence ring with logo



Sparco steering wheel Ø 350mm, full dish steering wheel available in leather or suede.
Hole interaxis: 6 x 70 mm



Code	Material
015R215CSN	Suede



Sparco steering wheel Ø 380mm, dished steering wheel optimal for off-road use. In black suede.
Hole interaxis: 6 x 70 mm.



Code	Material
015R368MSN	Suede

QUICK RELEASE STEERING WHEEL BOSS



Quick Release Steering wheel boss

The Lifeline Quick Release Steering Boss is available in three different formats:

Formula Car – 3 x 50.8 PCD

Touring Car – 6 x 70mm PCD steering wheel fitment e.g. Sparco

Group N/Tuning – allows you to use the quick release mechanism in conjunction with any aftermarket steering wheel boss that has a 6 x 70mm PCD steering wheel fitment.

Lifeline steering quick release bosses can be supplied with a pre-wired 8 way electrical connector to allow the use of steering wheel mounted instruments or switch gear, and in 2,3,4,5,6,7,10, 14 & 16 electrical connector arrangements (non pre-wired) to suit individual and constructor's needs, details upon request. All connectors are manufactured to IP50 specification.



410-100-001

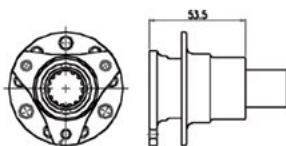

410-100-002

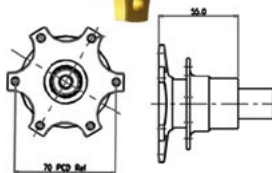

410-100-003
410-100-004 (black)

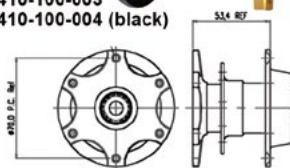

410-200-001

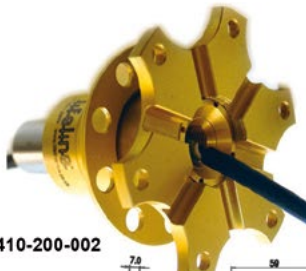
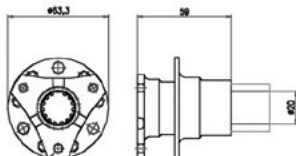

410-200-002

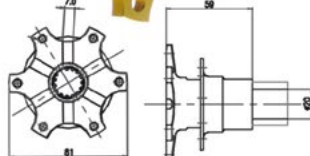

410-200-003

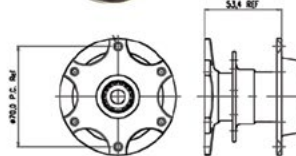

410-100-013

High angularity quick release steering wheel boss – 6 x 70mm PCD

As pit stop times are as crucial to the race performance of a vehicle as it's on track performance Lifeline has developed a quick release system that can give teams back valuable seconds. Allowing for a miss alignment of up to 100 Degrees this ingenious new design can compensate for wear allowing for a rapid and quality fit that requires little effort from the Driver every time the wheel is engaged. The optimised design also means that this new quick release from Lifeline is the lightest on the market today at under 290g.

Code	Description
410-100-001	Formula Car Quick Release
410-100-002	Touring/Rally Car
410-100-004	Group N Tuning - Black (Tuning market only)
410-200-001	Formula Car - Electric - 8 Pin - Pre Wired
410-200-002	Touring Car - Electric - 8 Pin - Pre-wired
410-200-003	Group N Touring Car - Electric - 8 Pin- Pre Wired
410-100-003	Group N

MIRRORS

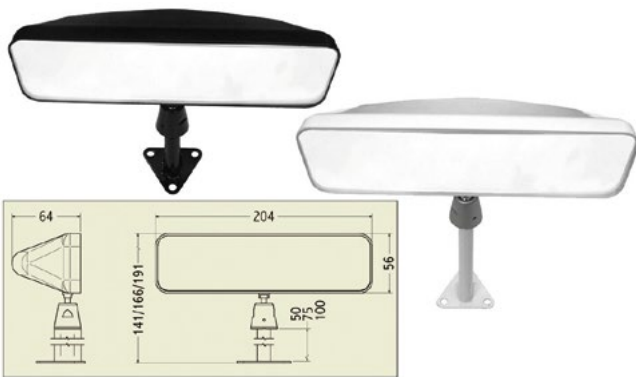

Lifeline
Fire & Safety Systems Ltd
Sport Cars

Lifeline mirror, available in three heights 50, 75 and 100 mm, in two colors with a flat or convex mirror of 200 x 52mm (104 cm²). Weight: 0,219 - 0,235 - 0,260 kg. Designed for central fixing in open top sports cars but are also ideal as a rear view mirror in a closed car.

Code	Mirror	Stem length	Colour
461-101-011	Convex	100 mm	Black
461-101-012	Convex	100 mm	White
461-101-003	Convex	50 mm	Black
461-101-004	Convex	50 mm	White
461-101-007	Convex	75 mm	Black
461-101-008	Convex	75 mm	White
461-101-009	Flat	100 mm	Black
461-101-010	Flat	100 mm	White
461-101-001	Flat	50 mm	Black
461-101-002	Flat	50 mm	White
461-101-005	Flat	75 mm	Black
461-101-006	Flat	75 mm	White

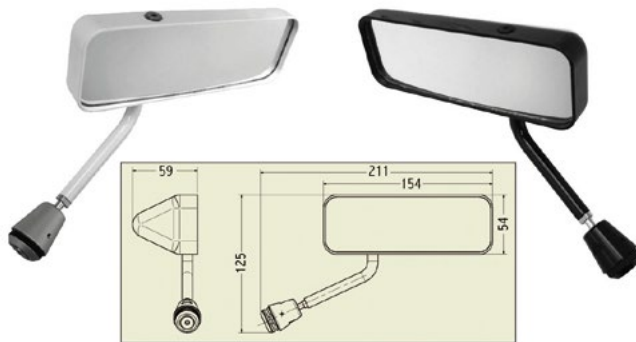

Lifeline
Fire & Safety Systems Ltd
FIA Formula Car

Lifeline mirror FIA compliant.
Dimensions: 150 x 50 mm (75 cm²) flat or convex.
Weight: 0,164 kg
Available in left or right hand version, black or white.
Formula Race Regulation compliant. (i.e. F3 Article 275:14.3.2).

Code	Hand	Mirror	Colour
461-102-001	Left hand	Flat	Black
461-102-002	Right hand	Flat	Black
461-102-003	Left hand	Flat	White
461-102-004	Right hand	Flat	White
461-102-005	Left hand	Convex	Black
461-102-006	Right hand	Convex	Black
461-102-007	Left hand	Convex	White
461-102-008	Right hand	Convex	White

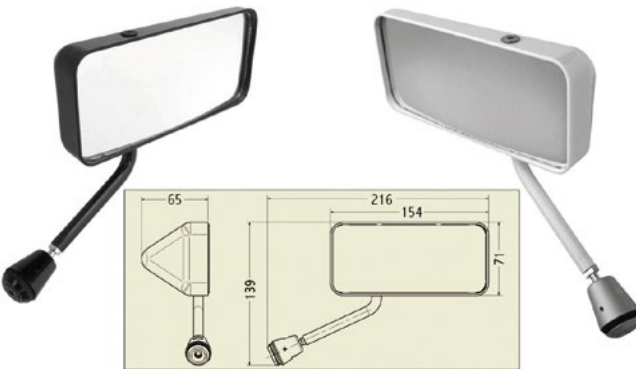

Lifeline
Fire & Safety Systems Ltd
FIA Touring GT

Lifeline Mirror for GT/Touring/Sport
Dimensions 151mm x 70mm (105.7cm²), flat or convex.
Available in left or right hand version, black or white. Weight: 0,194 kg
GT/Touring/Sports Cars complaint (i.e. GT Article 257:15.3 / Sportscars Article 258:15.3).

Code	Hand	Mirror	Colour
461-103-001	Left hand	Flat	Black
461-103-002	Right hand	Flat	Black
461-103-003	Left hand	Flat	White
461-103-004	Right hand	Flat	White
461-103-005	Left hand	Convex	Black
461-103-006	Right hand	Convex	Black
461-103-007	Left hand	Convex	White
461-103-008	Right hand	Convex	White

TOW EYES

sparco
Tow Eye



Code	Description
01627RS50	Tow Eye red 50 MM
01627RS80	Tow Eye red 80 MM

sparco
Tow Eye



Code	Description
01637MRRS	Tow Eye Martini Racing

sparco
Tow Eye



Code	Description
01637RS	Tow Eye red



Rain Lights

Static version of rain light. It has been designed specifically to meet the FIA technical specification introduced in 2008. Tested by BSi and homologated by the FIA in 2010 this light meets all requirements including minimum size, light intensity, viewing angle, heat resistance and prolonged use reliability. The design has been made robust enough to withstand the harsh environment of the race car whilst maintaining a small size and low weight.

Static. Only on/off
SPECIFICATION:

Size: 90mm X 58mm

Weight: 145g

Construction: One-piece solid resin moulding

Lighting: Fifteen 10mm multi-chip LEDs, 5x3 formation, 40cm² area

Intensity: 250cd straight ahead, 200cd @ 10deg Up, Down, Left,

Right (Universal orientation)

Mounting: Two M6 stainless steel studs

Electrical: 9V - 16V, 290mA @ 13.5V = 3.3W (static)



Code	Description
CK-LR-15-H	Cartek horizontal LED rain light
CK-LR-15-V	Cartek vertical LED rain light



Rain Lights

CARTEK have been developing 2 new FIA 2019 Specification Rain Lights (see attached instructions/datasheet). The new FIA 2019 Specification of Rain Lights is up to 3 times brighter than the previous 2008 specification.

They can be used in Static mode or Flashing 4Hz mode.

They can also be used as Rain Lights + Brake lights

A 3-position toggle switch can be bought separately for these Rain Lights (CK-LR-TS).

The FIA 2019 Rain Lights now come supplied with Type 99 Mil Spec cabling and DR-25 Heat shrink

Cartek is the first company to manufacture a circular Rain Light to the new FIA Specification.



Code	Description
CK-LRS-15RM	FIA RAIN LIGHT 3 Mode with switch - rectangular
CK-LRS-16CM	FIA RAIN LIGHT 3 Mode with switch - circular



Rain Lights Switch



Code	Description
CK-LR-TS	3 Position Toggle Switch for Rain Lights

PEDAL EXTENSIONS - FOOTRESTS



Pedal Extensions

3 piece set in pre-bent and shaperd mixed carbon. brake and clutch with no-slip inserts.



Code	Material	Colour
03783L	Carbon	Carbon



Co-driver Footrest

Codriver footboard

- 3mm thick non-slip checkerboard aluminium
- Double plate (lower and upper) for fixing to the floor and adjusting the inclination of the upper plate (4 inclinations available)
- Perforations for lightening with anti-tear embossing
- Lower plate with slots to adapt to any type of floor drilling
- Dimensions: 396x93x302mm



Codice	Material	Type	Colour	Note
03814AN2	Aluminium	Adjustable	Aluminium	4 angles



Drivers Footrest

Driver footboard

- 3mm thick non-slip checkerboard aluminium
- Perforations for lightening with anti-tear embossing
- Dimensions: 270x43x136mm



Codice	Material	Colour
03814AN1	Aluminium	Aluminium



Helmet lights

LEP-LIGHT is a high luminescence LED lamp designed for Stilo WRC DES helmets, but not only. Designed and built in collaboration with important Co-drivers and Drivers, its high versatility makes it a unique object of its kind that can be applied to any helmet, inside the passenger compartment thanks to the adhesive velcro and safety belt thanks to the specific hook. This last accessory has been specifically designed to perform night reconnaissance and to use it in regularity races where the helmet is not mandatory.

WINNING FEATURES:

- Duration up to 10 hours
- Simplicity and speed of use thanks to touch sensors
- Adjustable light and positioning
- Does not disturb the view of the user
- Rechargeable via micro USB 2.0 cable

TARGET:

- Co-driver: reading notes during special tests and night reconnaissance thanks to the practical belt clip
- Drivers and Co-drivers: in case of punctures, mechanical problems or accident
- Auto: applicable in the passenger compartment of any car for any need (even for non-sports use)
- On the track: for mechanics in pit stops in endurance races



Code	Colour
LEPLIGHT-NE	Black
LEPLIGHT-VE	Green



Map Lights



Code	Length
01628	49 cm



Fastening



Code	Description
03776	Cross spanner fastening



Protective sheets

Smooth technical sheets in Tecnocen, in the 3050 x 520 mm format for the construction of mud flaps, underbody protections, bodywork and chassis.

Available in 3 thicknesses.

For custom size cuts please contact Gieffe Racing.



Code	Colour	Thickness
T113NE90	Black	3 mm
T113R90	Red	3 mm
T114NE90	Black	4 mm
T114R90	Red	4 mm
T115NE90	Black	5 mm
T115R90	Red	5 mm



Roll-bar Padding

Roll-bar padding FIA approved
Sparco: Kit of 2 pcs x 50 cm
Lifeline: 1 pc x 60 cm



Code	Roll cages Ø	Kit	Brand
0076035	35 mm	2 pcs x 50 cm	Sparco
0076040	40 mm	2 pcs x 50 cm	Sparco
0076045	45 mm	2 pcs x 50 cm	Sparco
0076050	50 mm	2 pcs x 50 cm	Sparco
451-100-001	38-40 mm	1 pc x 60 cm	Lifeline
451-100-002	45 mm	1 pc x 60 cm	Lifeline
451-100-003	50 mm	1 pc x 60 cm	Lifeline
451-100-004	32 mm	1 pc x 60 cm	Lifeline
451-100-005	60 mm	1 pc x 60 cm	Lifeline



Fastening



Code	Description
03773	Spare wheel fastening tape



Window Nets

- Approved in compliance with FIA 2003 spec
- Valid contribution for greater safety
- Dimensions: 50 cm long, 52 cm high
- With Velcro tape for quick fastening to roll cage

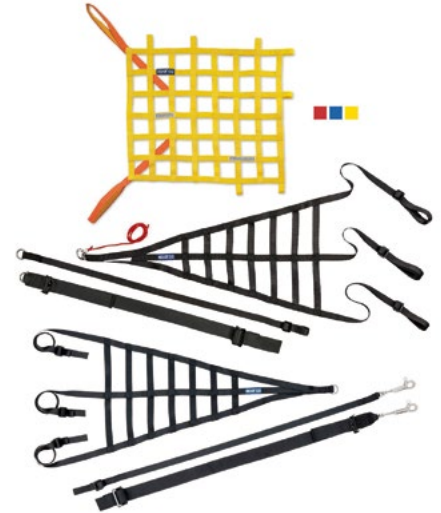

Code	Colour	Type
002192FA-BM	Navy Blue	Standard
002192FA-G	Yellow	Standard
002192FA-R	Red	Standard
002193NR	Black	Track - without preload
002194NR	Black	With preload



Notepad



Code	Description
03725	Sparco Note Book



Window Breaker



Code	Type
01613	With seatbelt cutter
01615	With seatbelt cutter + light